

Bidet - CL.1

Single-lever bidet mixer with pop-up waste - polished chrome

Article number: 33 600 670-00

- 130 mm projection
- fixed spout
- ball-joint pivotable through 30°
- rectangular, air-enriched flow
- height of mixer 188 mm
- height up to aerator 77 mm
- hole diameter 35 mm
- 2x screw-in M 10 x 1 pressure hose, leak-tested
- max. flow 7 l/min
- Fittings group as per DIN 4109: 1

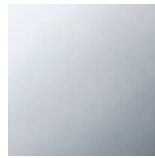

polished chrome

Dimensional drawing

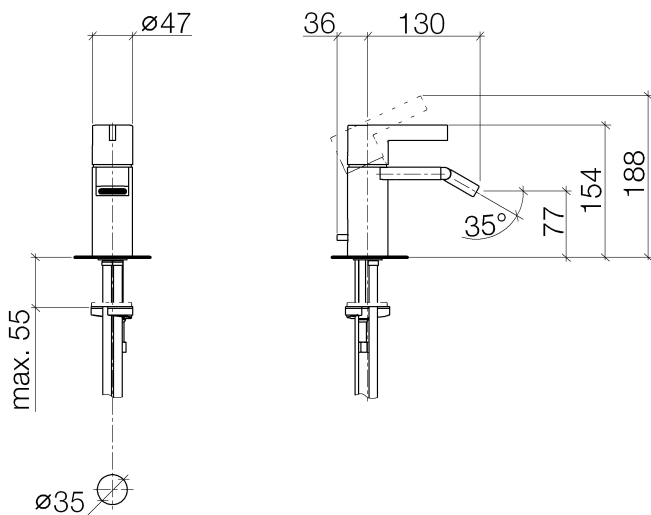

All details in mm / inch = mm x 0.0394



Bidet - CL.1

Single-lever bidet mixer with pop-up waste - polished chrome

Article number: 33 600 670-00

Flow rate chart

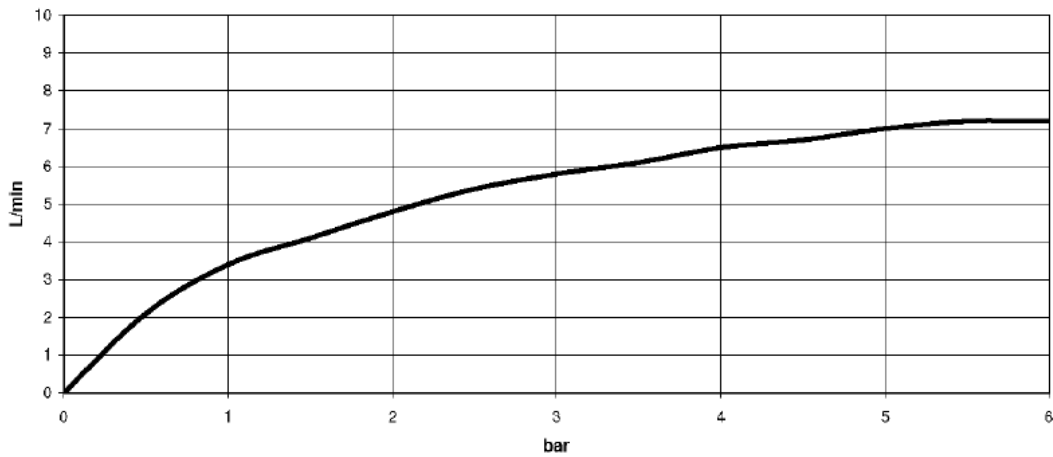

Trajectory diagram

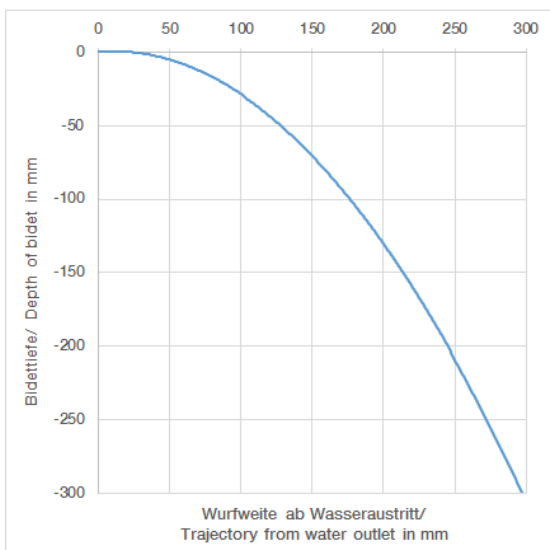
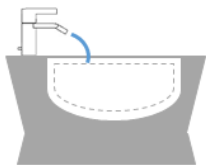



Bidet - CL.1

Single-lever bidet mixer with pop-up waste - polished chrome

Article number: 33 600 670-00

Other finish variants



platinum matt
33 600 670-06



platinum
33 600 670-08

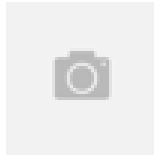

brushed Durabrass
33 600 670-28

Other finishes on request (x-tra Service)

Bidet - CL.1

Single-lever bidet mixer with pop-up waste - polished chrome

Article number: 33 600 670-00

Spare parts list

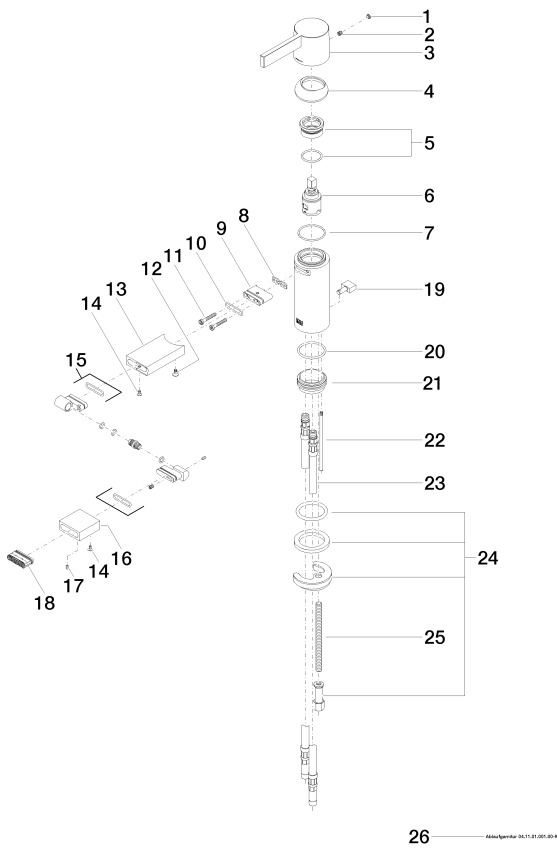

No.	Item Number	Name	Quantity used
1	90 31 20 087 00-00	plug	1
2	09 31 11 030 90	pin	1
3	09 20 67 003-00	handle	1
4	09 28 30 019-00	cover	1
5	90 23 10 066 00 90	nut	1
6	90 15 05 042 00 90	cartridge	1
7	09 14 10 102 90	seal	1
8	09 14 03 131 90	seal	1
9	09 11 03 061 90	connection	1
10	09 14 10 053 90	seal	1
11	09 30 30 084 90	screw	2
12	09 30 30 116 90	screw	1
13	09 28 22 246-00	spout	1
14	09 30 30 157 90	screw	2
15	90 24 02 083 00-00	joint	1
16	09 23 01 123-00	sleeve	1
17	09 31 11 064 90	pin	1
18	90 29 03 045 00 90	aerator	1
19	09 20 67 002-00	handle	1
20	09 14 10 119 90	seal	1
21	09 28 10 109-07	ring	1
22	09 31 09 080-00	pull-rod	1
23	04 30 04 016 00 90	hose	2
24	04 30 11 085 62 90	fixing set	1
25	09 31 11 012 90	pin	1
26	04 11 01 001 00-00	pop-up waste	1