

TECHNICAL SCHEDULE

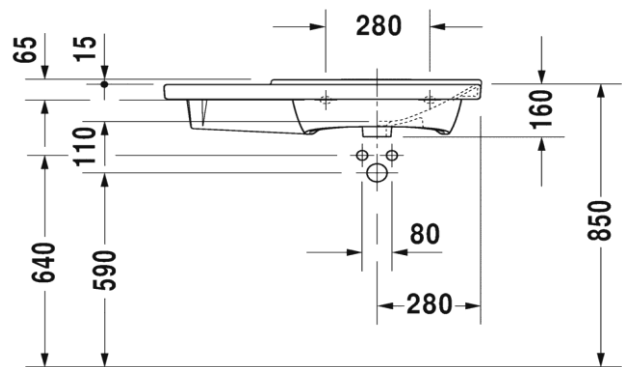

P3 asymmetrical furniture basin with overflow and tap platform

Code: 2334.85

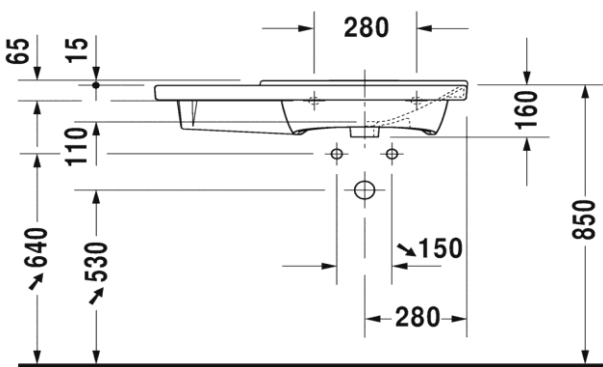
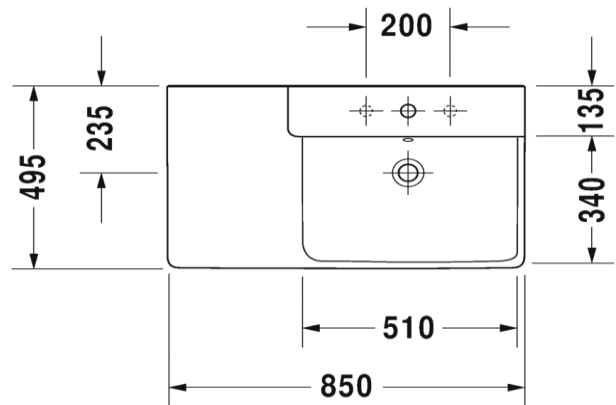
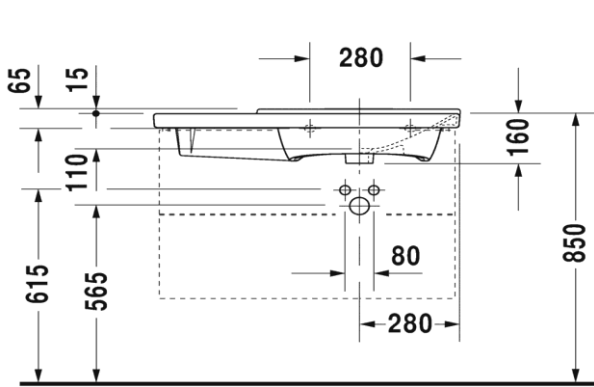

Inspirational + European + Bathroomware

t 09 444 5656

e info@metrix.co.nz

www.metrix.co.nz