

DURAVIT ME by Starck

Duravit ME by Starck back to wall toilet suite
(Requires soft close seat 020.19)

2170.09

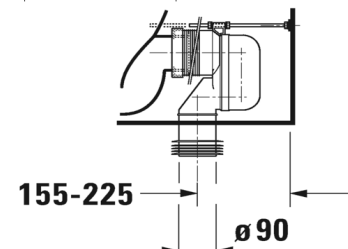
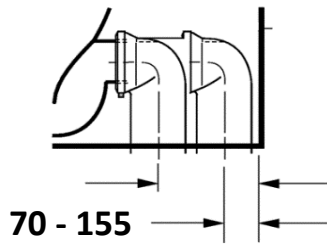
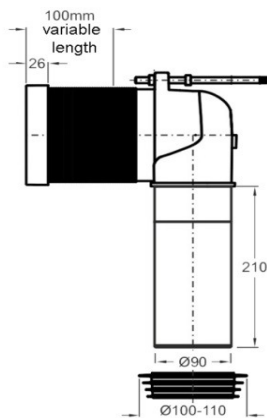
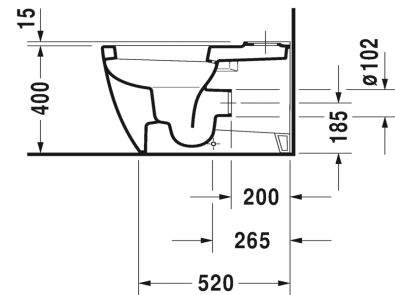
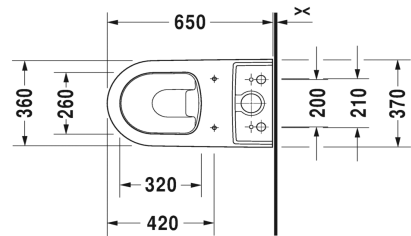
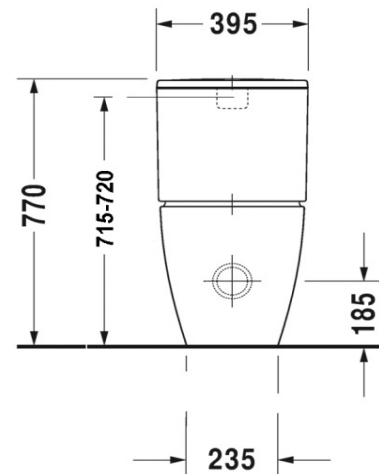

5 Year warranty (Vitreous China)

WELS Rating: 4 Star - 4.5/3 L

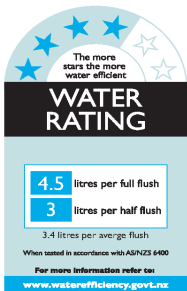

Max. Operating Pressure: 500Kpa.

Min. Operating Pressure: 50Kpa.

Pipework must be flushed before installation

Please install as per manufacturers instructions in the box

Above connector sold separately, if required

#8990250000

Due to our policy of continuous product development, the design and specification shown are subject to change without notice.

Please confirm all particulars with your sales consultant prior to purchase.

